

Article number: 03506030

Description: Fluro Rod end GE 30FO-2RS

Measures

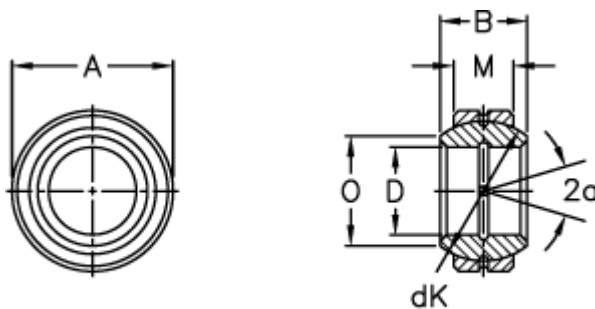

Str. 6–12 uden smørerille

A	= 55 0 -0,013	Tilt angle = 17
B	= 32	Weight = 290
D	= 30 0 -0,010	
dK	= 47	
Dynamic load C (kN)	= 80	
M	= 20	
O	= 34.4	
Static load C0 (kN)	= 400	